

**Phase leg  
Trench + Field Stop IGBT<sup>®</sup>  
Power Module**

**$V_{CES} = 1700V$   
 $I_C = 300A @ T_c = 80^{\circ}C$**

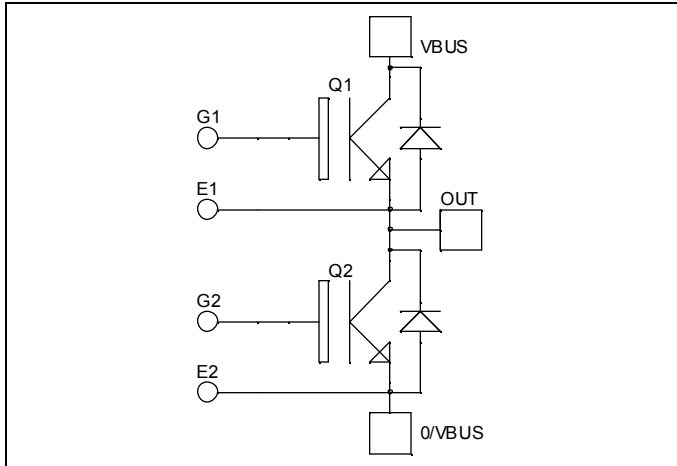

### Application

- Welding converters
- Switched Mode Power Supplies
- Uninterruptible Power Supplies
- Motor control

### Features

- Trench + Field Stop IGBT<sup>®</sup> Technology
  - Low voltage drop
  - Low tail current
  - Switching frequency up to 20 kHz
  - Soft recovery parallel diodes
  - Low diode VF
  - Low leakage current
  - Avalanche energy rated
  - RBSOA and SCSOA rated
- Kelvin emitter for easy drive
- Very low stray inductance
  - Symmetrical design
  - M5 power connectors
- High level of integration

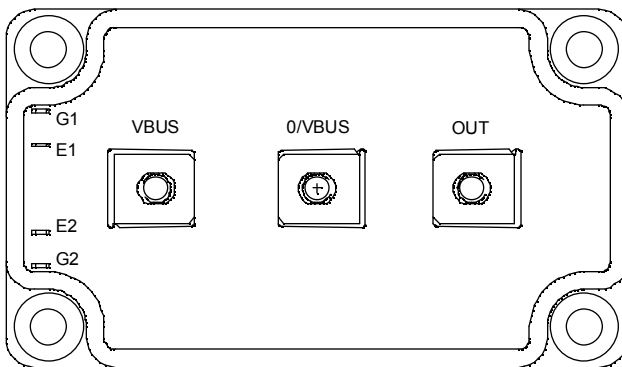

### Benefits

- Stable temperature behavior
- Very rugged
- Direct mounting to heatsink (isolated package)
- Low junction to case thermal resistance
- Easy paralleling due to positive TC of VCESat
- Low profile
- RoHS Compliant

### Absolute maximum ratings

Symbol	Parameter	Max ratings	Unit
$V_{CES}$	Collector - Emitter Breakdown Voltage	1700	V
$I_C$	Continuous Collector Current	$T_c = 25^{\circ}C$	400
		$T_c = 80^{\circ}C$	300
$I_{CM}$	Pulsed Collector Current	$T_c = 25^{\circ}C$	600
$V_{GE}$	Gate - Emitter Voltage	$\pm 20$	V
$P_D$	Maximum Power Dissipation	$T_c = 25^{\circ}C$	1660
RBSOA	Reverse Bias Safe Operating Area	$T_j = 125^{\circ}C$	600A @ 1600V

**CAUTION:** These Devices are sensitive to Electrostatic Discharge. Proper Handling Procedures Should Be Followed. See application note APT0502 on [www.microsemi.com](http://www.microsemi.com)

All ratings @  $T_j = 25^\circ\text{C}$  unless otherwise specified

**Electrical Characteristics**

Symbol	Characteristic	Test Conditions	Min	Typ	Max	Unit
$I_{CES}$	Zero Gate Voltage Collector Current	$V_{GE} = 0\text{V}, V_{CE} = 1700\text{V}$			750	$\mu\text{A}$
$V_{CE(sat)}$	Collector Emitter Saturation Voltage	$V_{GE} = 15\text{V}$ $I_C = 300\text{A}$	$T_j = 25^\circ\text{C}$	2.0	2.4	V
			$T_j = 125^\circ\text{C}$	2.4		
$V_{GE(th)}$	Gate Threshold Voltage	$V_{GE} = V_{CE}, I_C = 5\text{mA}$	5.0	5.8	6.5	V
$I_{GES}$	Gate – Emitter Leakage Current	$V_{GE} = 20\text{V}, V_{CE} = 0\text{V}$			600	nA

**Dynamic Characteristics**

Symbol	Characteristic	Test Conditions	Min	Typ	Max	Unit
$C_{ies}$	Input Capacitance	$V_{GE} = 0\text{V}$		26.5		nF
$C_{oes}$	Output Capacitance	$V_{CE} = 25\text{V}$		1.1		
$C_{res}$	Reverse Transfer Capacitance	$f = 1\text{MHz}$		0.88		
$T_{d(on)}$	Turn-on Delay Time	Inductive Switching ( $25^\circ\text{C}$ )		370		ns
$T_r$	Rise Time	$V_{GE} = 15\text{V}$		40		
$T_{d(off)}$	Turn-off Delay Time	$V_{Bus} = 900\text{V}$		650		
$T_f$	Fall Time	$I_C = 300\text{A}$ $R_G = 2.2\Omega$		180		
$T_{d(on)}$	Turn-on Delay Time	Inductive Switching ( $125^\circ\text{C}$ )		400		ns
$T_r$	Rise Time	$V_{GE} = 15\text{V}$		50		
$T_{d(off)}$	Turn-off Delay Time	$V_{Bus} = 900\text{V}$		800		
$T_f$	Fall Time	$I_C = 300\text{A}$ $R_G = 2.2\Omega$		300		
$E_{on}$	Turn-on Switching Energy	$V_{GE} = 15\text{V}$ $V_{Bus} = 900\text{V}$	$T_j = 125^\circ\text{C}$	96		mJ
$E_{off}$	Turn-off Switching Energy	$I_C = 300\text{A}$ $R_G = 2.2\Omega$	$T_j = 125^\circ\text{C}$	94		

**Reverse diode ratings and characteristics**

Symbol	Characteristic	Test Conditions	Min	Typ	Max	Unit
$V_{RRM}$	Maximum Peak Repetitive Reverse Voltage		1700			V
$I_{RM}$	Maximum Reverse Leakage Current	$V_R = 1700\text{V}$	$T_j = 25^\circ\text{C}$		750	$\mu\text{A}$
			$T_j = 125^\circ\text{C}$		1000	
$I_F$	DC Forward Current		$T_c = 80^\circ\text{C}$	300		A
$V_F$	Diode Forward Voltage	$I_F = 300\text{A}$	$T_j = 25^\circ\text{C}$	1.8	2.2	V
			$T_j = 125^\circ\text{C}$	1.9		
$t_{rr}$	Reverse Recovery Time	$I_F = 300\text{A}$ $V_R = 900\text{V}$ $di/dt = 3200\text{A}/\mu\text{s}$	$T_j = 25^\circ\text{C}$	385		ns
			$T_j = 125^\circ\text{C}$	490		
$Q_{rr}$	Reverse Recovery Charge		$T_j = 25^\circ\text{C}$	76		$\mu\text{C}$
			$T_j = 125^\circ\text{C}$	124		
$E_r$	Reverse Recovery Energy		$T_j = 25^\circ\text{C}$	35		mJ
			$T_j = 125^\circ\text{C}$	70		



## Typical Performance Curve

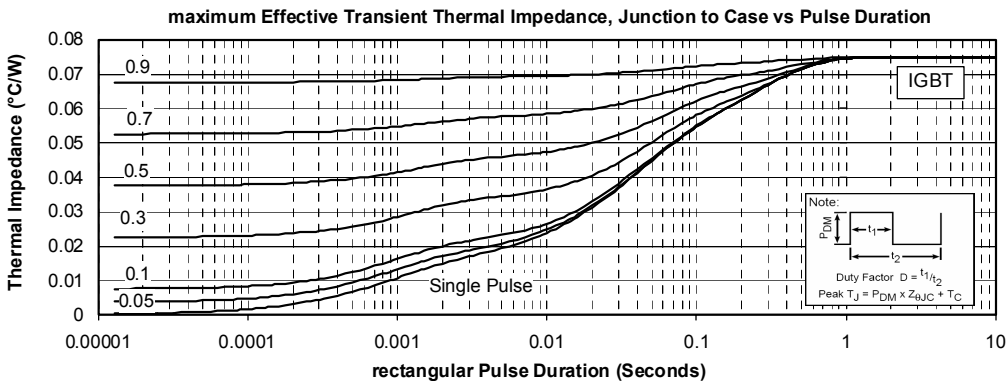
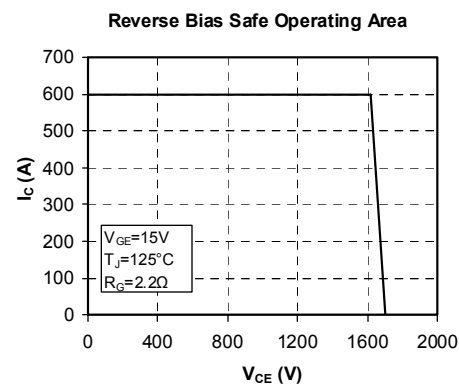
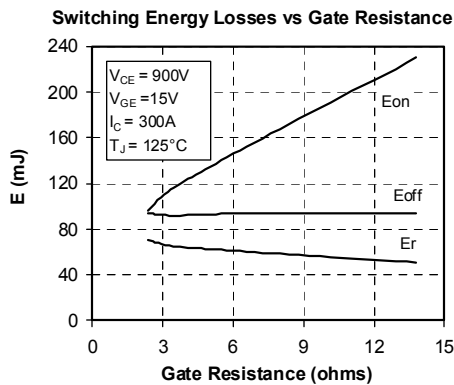
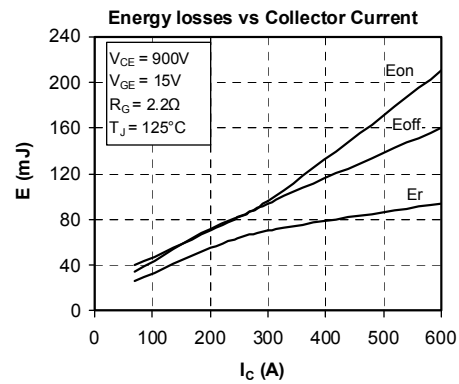
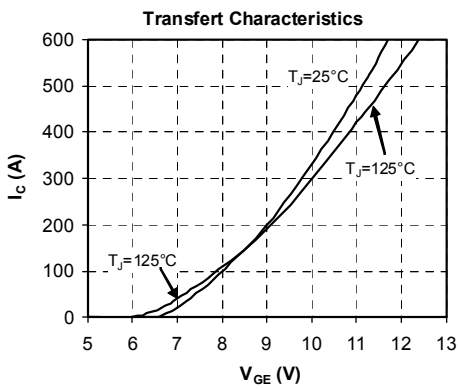
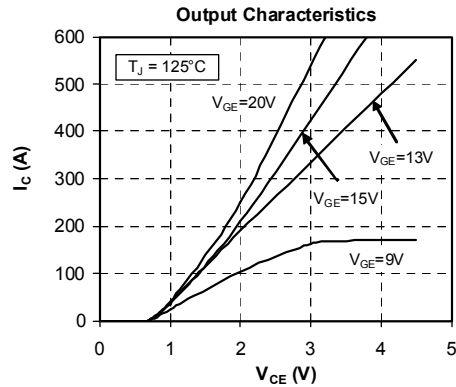
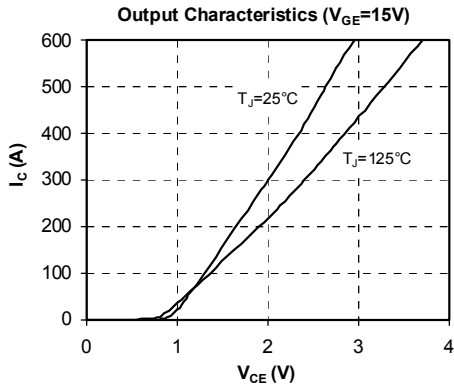

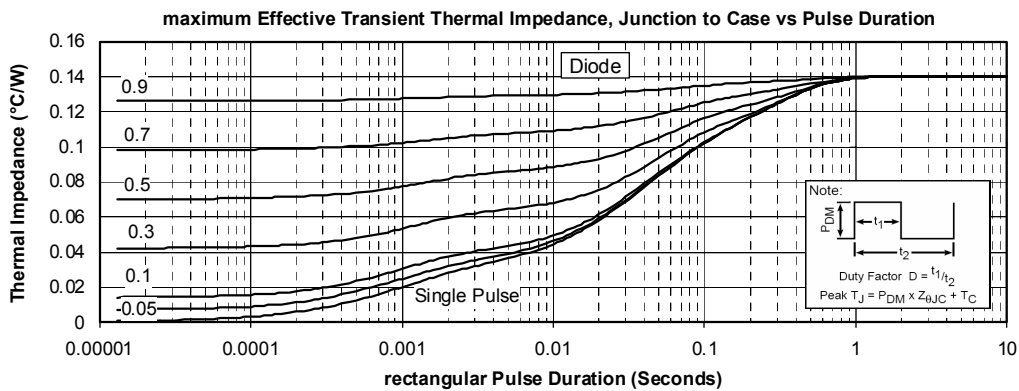
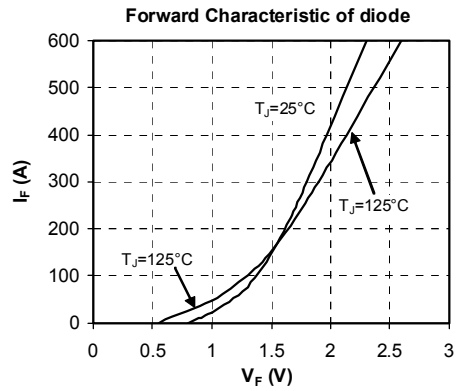
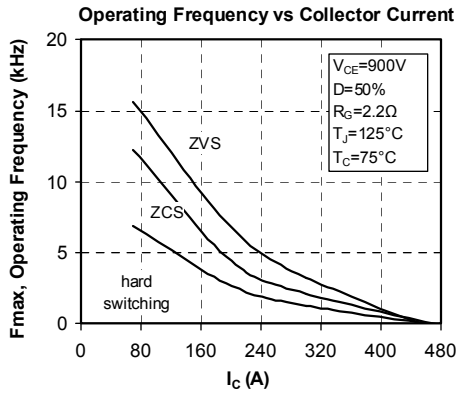

Microsemi reserves the right to change, without notice, the specifications and information contained herein

Microsemi's products are covered by one or more of U.S. patents 4,895,810 5,045,903 5,089,434 5,182,234 5,019,522 5,262,336 6,503,786 5,256,583 4,748,103 5,283,202 5,231,474 5,434,095 5,528,058 and foreign patents. U.S. and Foreign patents pending. All Rights Reserved.